

Solutions

1. Ans. E.

- 1) 3 persons are sitting between M and N.
- 2) K is third to the right of N.
- 3) K is second to the left of P.

Case-1 M _ _ _ N _ _ K _ P

Case-2 N _ _ K M P

4) The number of people between M and P is the same as the number of people between M and L.

(Here case - 2 will get neglected as there is no space for L to sit.)

5) Only three people sit to the left of L.

6) Six people sit between L and J.

7) Two people sit between P and R.

8) R is sitting at the second position from one of the ends.

___ L _ _ _ _ _ J _ M _ _ _ N _ _ K _ P
_ _ R _

The above arrangement will be the final arrangement.

Hence, there are a total of 26 persons in the row.

2. Ans. A.

- 1) 3 persons are sitting between M and N.
- 2) K is third to the right of N.
- 3) K is second to the left of P.

Case-1 M _ _ _ N _ _ K _ P

Case-2 N _ _ K M P

4) The number of people between M and P is the same as the number of people between M and L.

(Here case - 2 will get neglected as there is no space for L to sit.)

5) Only three people sit to the left of L.

6) Six people sit between L and J.

7) Two people sit between P and R.

8) R is sitting at the second position from one of the ends.

___ L _ _ _ _ _ J _ M _ _ _ N _ _ K _ P
_ _ R _

The above arrangement will be the final arrangement.

Hence, there are a total of 26 persons in the row.

Hence, J sits 2nd to the left of M.

3. Ans. C.

- 1) 3 persons are sitting between M and N.
- 2) K is third to the right of N.
- 3) K is second to the left of P.

Case-1 M _ _ _ N _ _ K _ P

Case-2 N _ _ K M P

4) The number of people between M and P is the same as the number of people between M and L.

(Here case - 2 will get neglected as there is no space for L to sit.)

5) Only three people sit to the left of L.

6) Six people sit between L and J.

7) Two people sit between P and R.

8) R is sitting at the second position from one of the ends.

___ L _ _ _ _ _ J _ M _ _ _ N _ _ K _ P
_ _ R _

The above arrangement will be the final arrangement.

Hence, there are a total of 26 persons in the row.

Eight people sit between M and P.

4. Ans. B.

- 1) 3 persons are sitting between M and N.
- 2) K is third to the right of N.
- 3) K is second to the left of P.

Case-1 M _ _ _ N _ _ K _ P

Case-2 N _ _ K M P

4) The number of people between M and P is the same as the number of people between M and L.

(Here case - 2 will get neglected as there is no space for L to sit.)

5) Only three people sit to the left of L.

6) Six people sit between L and J.

7) Two people sit between P and R.

8) R is sitting at the second position from one of the ends.

___ L _ _ _ _ _ J _ M _ _ _ N _ _ K _ P
_ _ R _

The above arrangement will be the final arrangement.

Hence, there are a total of 26 persons in the row.

A) J sits to the right of K. ⇒ False

B) Seven people are sitting between N and R.
⇒ True

C) Less than 10 people sit between P and L.

⇒ False

D) 9 people sit between J and P. ⇒ False

5. Ans. A.

1) 3 persons are sitting between M and N.

2) K is third to the right of N.

3) K is second to the left of P.

Case-1 M _ _ _ N _ _ _ K _ P

Case-2 N _ _ _ K M P

4) The number of people between M and P is the same as the number of people between M and L.

(Here case – 2 will get neglected as there is no space for L to sit.)

5) Only three people sit to the left of L.

6) Six people sit between L and J.

7) Two people sit between P and R.

8) R is sitting at the second position from one of the ends.

___ L _ _ _ _ J _ M _ _ _ N _ _ _ K _ P
 ___ R _ _

The above arrangement will be the final arrangement.

Hence, there are a total of 26 persons in the row.

19 people are sitting to the left of K.

6. Ans. D.

People: D, E, F, G, H, I, J and K.

Note – 1: 4 sit at the corner facing outside and 4 sit in the middle of the sides facing the centre.

1) E does not sit at any of the corners of the table.

(Therefore, E sit at the middle of the side)

2) Only 3 people sit between D and E.

3) D is not an immediate neighbour of I or J and sits second to the left of K.

4) F sits second to the right of G only 3 people sit between F and J.

5) Only 1 person sits between J and I (either from left or right).

(Now the only leftover person is H and will sit in the only left place)

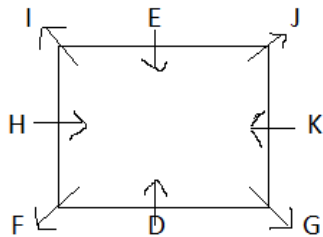

The above arrangement will be the final arrangement.

G sit 3rd to the right of H.

7. Ans. C.

People: D, E, F, G, H, I, J and K.

Note – 1: 4 sit at the corner facing outside and 4 sit in the middle of the sides facing the centre.

1) E does not sit at any of the corners of the table.

(Therefore, E sit at the middle of the side)

2) Only 3 people sit between D and E.

3) D is not an immediate neighbour of I or J and sits second to the left of K.

4) F sits second to the right of G only 3 people sit between F and J.

5) Only 1 person sits between J and I (either from left or right).

(Now the only leftover person is H and will sit in the only left place)

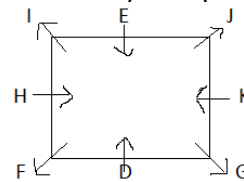

The above arrangement will be the final arrangement.

I sits to the immediate right of E.

8. Ans. C.

People: D, E, F, G, H, I, J and K.

Note – 1: 4 sit at the corner facing outside and 4 sit in the middle of the sides facing the centre.

1) E does not sit at any of the corners of the table.

(Therefore, E sit at the middle of the side)

2) Only 3 people sit between D and E.

3) D is not an immediate neighbour of I or J and sits second to the left of K.

4) F sits second to the right of G only 3 people sit between F and J.

5) Only 1 person sits between J and I (either from left or right).

(Now the only leftover person is H and will sit in the only left place)

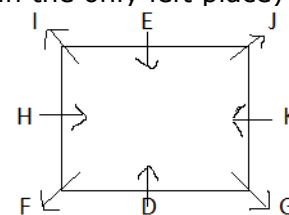

The above arrangement will be the final arrangement.

I. G is facing inside. ⇒ False (as G faces outside)

II. H is an immediate neighbour of J. ⇒ False (H is 3rd to left of J)

III. G is sitting to the immediate left of K. ⇒ True

Hence, Only conclusion III follows.

9. Ans. E.

People: D, E, F, G, H, I, J and K.

Note - 1: 4 sit at the corner facing outside and 4 sit in the middle of the sides facing the centre.

1) E does not sit at any of the corners of the table.

(Therefore, E sit at the middle of the side)

2) Only 3 people sit between D and E.

3) D is not an immediate neighbour of I or J and sits second to the left of K.

4) F sits second to the right of G only 3 people sit between F and J.

5) Only 1 person sits between J and I (either from left or right).

(Now the only leftover person is H and will sit in the only left place)

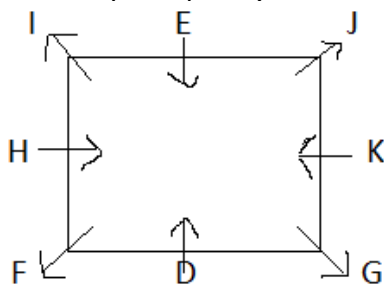

The above arrangement will be the final arrangement.

F, J, G, I → Group of people sitting at the corners.

K → sits at the middle of the side.

Hence, K does not belong to the group.

10. Ans. D.

People: D, E, F, G, H, I, J and K.

Note - 1: 4 sit at the corner facing outside and 4 sit in the middle of the sides facing the centre.

1) E does not sit at any of the corners of the table.

(Therefore, E sit at the middle of the side)

2) Only 3 people sit between D and E.

3) D is not an immediate neighbour of I or J and sits second to the left of K.

4) F sits second to the right of G only 3 people sit between F and J.

5) Only 1 person sits between J and I (either from left or right).

(Now the only leftover person is H and will sit in the only left place)

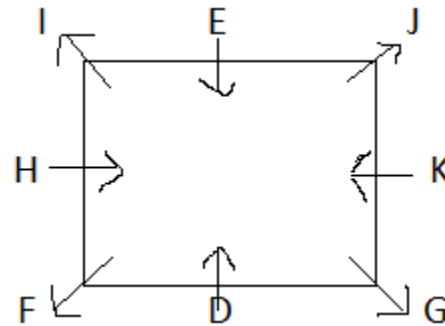

The above arrangement will be the final arrangement.

When we count from the right of J, K is an immediate neighbour of J.

Hence, none sits between J and K when counted from the right of J.

11. Ans. A.

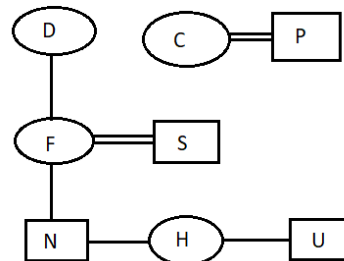

If P is the father-in-law of F, then C is the wife of F.

C is the grandmother of U.

12. Ans. B.

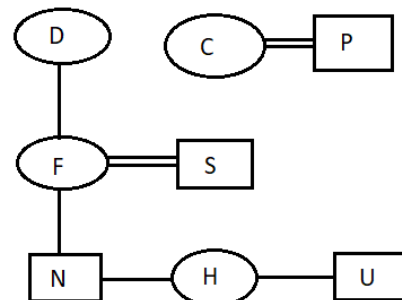

H is the daughter of F.

13. Ans. A.

Member: C, D, H, N, P, S and U

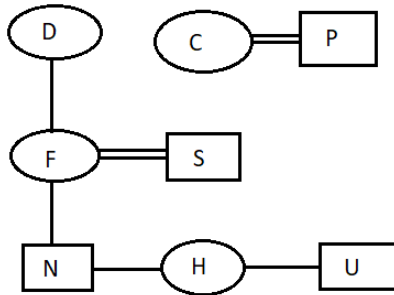

Hence, N is the grandson of D.

14. Ans. A.

Given: $A \geq B > F$; $B > M > O$; $F > S$; $R < S$

Conclusion:

I. $S < A \Rightarrow$ True (as $A > F > S$)

II. $F < O \Rightarrow$ False (as $B > F$; $B > O$ therefore we can't find exact relationship between them)

Hence, only conclusion I follows.

15. Ans. E.

Given: $D \leq R > E \leq B$; $S \leq M = E > D$; $G > B$

Conclusion:

I. $D > G \Rightarrow$ False (as $E \leq B$; $E > D$ and $G > B \rightarrow G > B \geq E > D \rightarrow G > D$)

II. $B < R \Rightarrow$ False ($D \leq R > E$ and $B \geq E > D \rightarrow B \geq E > D \leq R$)

Hence, Neither I nor II follows.

16. Ans. C.

Given: $E \leq S > F \leq C$; $T \leq N = F > E$; $H > C$

Conclusion:

1) $T < C \Rightarrow$ False (as $F \leq C$; $T \leq N = F \Rightarrow T \leq F \leq C$ therefore $T \leq C$)

2) $C = T \Rightarrow$ False (as $F \leq C$; $T \leq N = F \Rightarrow T \leq F \leq C$ therefore $T \leq C$)

As $T \leq C$ therefore either $T < C$ or $T = C$.

Hence, either I or II follows.

17. Ans. B.

Given: $M = L \geq N \geq Q < P < V \geq S$; $Q > G$

On Combining: $M = L \geq N \geq Q > G$; $G < P < V \geq S$

Conclusion:

1) $G \geq S \Rightarrow$ False (as $G < P < V \geq S$ therefore we can't find any relationship between G and S)

2) $M > G \Rightarrow$ True (as $M = L \geq N \geq Q > G$)

Hence, Only conclusion II follows.

18. Ans. D.

Given: $Q > A \geq Z \leq X \leq C$; $Z \geq H$

On combining: $Q > A \geq Z \geq H$; $H \leq Z \leq X \leq C$

Conclusion:

1) $Q > H \Rightarrow$ True (as $Q > A \geq Z \geq H$)

2) $Z \leq C \Rightarrow$ True (as $H \leq Z \leq X \leq C$)

Hence, both conclusions I and II follow.

19. Ans. B.

1) There are 5 boxes between box P and box R.

2) Box T is kept immediately above R.

3) 3 boxes are kept between box T and box S.

Case - 1	Case - 2
	T
P	R
S	
	S
T	
R	P

4) Number of boxes between P and S is same as the number of boxes between T and Q.

Case - 1	Case - 2
	T
P	R
S	
	Q
	S
Q	
T	
R	P

5) Box U is kept below box Q.

6) There is only one box kept between U and V.

(Therefore Case - 1 will get eliminated)

6) Box W is kept somewhere below X.

Case - 2
T
R
X
Q
S
W
U
P
V

Above arrangement is final.

- I. Two boxes between T and Q. \Rightarrow True
 - II. S is kept below W. \Rightarrow False (S is kept above W)
 - III. U is kept immediately above P. \Rightarrow True
- Hence, only II is not true.

20. Ans. A.

- 1) There are 5 boxes between box P and box R.
- 2) Box T is kept immediately above R.
- 3) 3 boxes are kept between box T and box S.

Case - 1	Case - 2
	T
P	R
S	
	S
T	
R	P

4) Number of boxes between P and S is same as the number of boxes between T and Q.

Case - 1	Case - 2
	T
P	R
S	
	Q
	S
Q	
T	
R	P

- 5) Box U is kept below box Q.
- 6) There is only one box kept between U and V.
(Therefore Case - 1 will get eliminated)
- 6) Box W is kept somewhere below X.

Case - 2
T
R
X
Q
S
W
U
P
V

Above arrangement is final.

V is related P \Rightarrow V is immediately below P.
Q is related to X \Rightarrow Q is immediately below X.

Similarly, U is immediately below W.
Hence, U is related to W.

21. Ans. D.

- 1) There are 5 boxes between box P and box R.
- 2) Box T is kept immediately above R.
- 3) 3 boxes are kept between box T and box S.

Case - 1	Case - 2
	T
P	R
S	
	S
T	
R	P

4) Number of boxes between P and S is same as the number of boxes between T and Q.

Case - 1	Case - 2
	T
P	R
S	
	Q
	S
Q	
T	
R	P

- 5) Box U is kept below box Q.
 6) There is only one box kept between U and V.
 (Therefore Case - 1 will get eliminated)
 6) Box W is kept somewhere below X.

Case - 2
T
R
X
Q
S
W
U
P
V

Above arrangement is final.
 Four boxes kept between P and X.

22. Ans. A.

- 1) There are 5 boxes between box P and box R.
 2) Box T is kept immediately above R.
 3) 3 boxes are kept between box T and box S.

Case - 1	Case - 2
	T
P	R
S	
	S
T	
R	P

4) Number of boxes between P and S is same as the number of boxes between T and Q.

Case - 1	Case - 2
	T
P	R
S	
	Q
	S
Q	
T	
R	P

- 5) Box U is kept below box Q.
 6) There is only one box kept between U and V.
 (Therefore Case - 1 will get eliminated)
 6) Box W is kept somewhere below X.

Case - 2
T
R
X
Q
S
W
U
P
V

Above arrangement is final.
 Box immediately above Q ⇒ X
 Box immediately below Q ⇒ S
 Hence, XS is the pair of boxes kept immediately above and below box Q respectively

23. Ans. D.

- 1) There are 5 boxes between box P and box R.
 2) Box T is kept immediately above R.
 3) 3 boxes are kept between box T and box S.

Case - 1	Case - 2
	T
P	R
S	
	S
T	
R	P

4) Number of boxes between P and S is same as the number of boxes between T and Q.

Case - 1	Case - 2
	T
P	R
S	
	Q
	S
Q	
T	
R	P

5) Box U is kept below box Q.
 6) There is only one box kept between U and V.
 (Therefore Case - 1 will get eliminated)
 6) Box W is kept somewhere below X.

Case - 2
T
R
X
Q
S
W
U
P
V

Above arrangement is final.
 Position of box W is fourth from bottom.

24. Ans. A.
 Given Word: **UNDERNEATH**
 first, fourth, sixth and ninth letters are U, E, N, T

Word formed ⇒ TUNE
 First letter of word is 'T'.

25. Ans. A.

Letter	T	R	A	N	S	P	O	R	T
Number	20	18	1	14	19	16	15	18	20

Pairs → PO, NR, PR, NP
 Hence, there are four such pairs.

26. Ans. B.

Person: P, Q, R, S, T, U, V and W

Birth year: 1945, 1956, 1961, 1973, 1978, 1989, 1996 and 2007

1) S was born in an odd number year.
 2) The difference between the present age of S and V is 5.

(as a difference of 5 years is between the person born in 1956 and 1961 and person born in 1973 and 1978 as S born in an odd-numbered year, therefore, S born either in 1961 or 1973 and V born in 1956 and 1978)

3) Only 3 people were born between V and T.

		Case - 1	Case - 2
Year	Age	Person	Person
1945	73		T
1956	62	V	
1961	57	S	
1973	45		S
1978	40		V
1989	29	T	
1996	22		
2007	11		

4) The number of people born between T and Q is the same as the number of people born between T and P.

(As we can see in the above table it is the only possibility that P and Q born just before and after T or only one person between born between P and T and T and Q)

(here case - 2 will get eliminated as in this case it is not possible that people born between T and P is the same as T and Q)

5) The present age of W is twice the present age of Q.

(This is only possible if Q's age is 11 years and W's age is 22 years)

Case – 1		
Year	Age	Person
1945	73	
1956	62	V
1961	57	S
1973	45	P
1978	40	
1989	29	T
1996	22	W
2007	11	Q

5) R was born in one of the years before P.
(Now only U is left and the only birthyear left is 1978. Therefore, U born in 1978)

Year	Age	Person
1945	73	R
1956	62	V
1961	57	S
1973	45	P
1978	40	U
1989	29	T
1996	22	W
2007	11	Q

Above combination will be the final combination.

S was born in 1961. Therefore, the current age of S (wrt 2018) ⇒ 57 years
Age of S after 4 years = 57 + 4 = 61 years.

27. Ans. E.

Person: P, Q, R, S, T, U, V and W

Birth year: 1945, 1956, 1961, 1973, 1978, 1989, 1996 and 2007

1) S was born in an odd number year.

2) The difference between the present age of S and V is 5.

(as a difference of 5 years is between the person born in 1956 and 1961 and person born in 1973 and 1978 as S born in an odd-numbered year, therefore, S born either in 1961 or 1973 and V born in 1956 and 1978)

3) Only 3 people were born between V and T.

		Case – 1	Case – 2
Year	Age	Person	Person
1945	73		T
1956	62	V	
1961	57	S	
1973	45		S
1978	40		V
1989	29	T	
1996	22		
2007	11		

4) The number of people born between T and Q is the same as the number of people born between T and P.

(As we can see in the above table it is the only possibility that P and Q born just before and after T or only one person between born between P and T and T and Q)

(here case – 2 will get eliminated as in this case it is not possible that people born between T and P is the same as T and Q)

5) The present age of W is twice the present age of Q.

(This is only possible if Q's age is 11 years and W's age is 22 years)

Case – 1		
Year	Age	Person
1945	73	
1956	62	V
1961	57	S
1973	45	P
1978	40	
1989	29	T
1996	22	W
2007	11	Q

5) R was born in one of the years before P.

(Now only U is left and the only birthyear left is 1978. Therefore, U born in 1978)

Year	Age	Person
1945	73	R
1956	62	V
1961	57	S
1973	45	P
1978	40	U
1989	29	T
1996	22	W
2007	11	Q

Above combination will be the final combination.

T born before W and after U.

28. Ans. A.

Person: P, Q, R, S, T, U, V and W

Birth year: 1945, 1956, 1961, 1973, 1978, 1989, 1996 and 2007

1) S was born in an odd number year.

2) The difference between the present age of S and V is 5.

(as a difference of 5 years is between the person born in 1956 and 1961 and person born in 1973 and 1978 as S born in an odd-numbered year, therefore, S born either in 1961 or 1973 and V born in 1956 and 1978)

3) Only 3 people were born between V and T.

		Case – 1	Case – 2
Year	Age	Person	Person
1945	73		T
1956	62	V	
1961	57	S	
1973	45		S
1978	40		V
1989	29	T	
1996	22		
2007	11		

4) The number of people born between T and Q is the same as the number of people born between T and P.

(As we can see in the above table it is the only possibility that P and Q born just before and after T or only one person between born between P and T and T and Q)

(here case – 2 will gets eliminated as in this case it is not possible that people born between T and P is the same as T and Q)

5) The present age of W is twice the present age of Q.

(This is only possible if Q's age is 11 years and W's age is 22 years)

		Case – 1
Year	Age	Person
1945	73	
1956	62	V
1961	57	S
1973	45	P
1978	40	
1989	29	T
1996	22	W
2007	11	Q

5) R was born in one of the years before P. (Now only U is left and the only birthyear left is 1978. Therefore, U born in 1978)

Year	Age	Person
1945	73	R
1956	62	V
1961	57	S
1973	45	P
1978	40	U
1989	29	T
1996	22	W
2007	11	Q

Above combination will be the final combination.

S was born in 1961. Therefore, the age of S ⇒ 57 years

R born in 1945. Therefore, the age of R ⇒ 73 years

Difference between the ages of S and R = 73 – 57 = 16 years

29. Ans. C.

Person: P, Q, R, S, T, U, V and W

Birth year: 1945, 1956, 1961, 1973, 1978, 1989, 1996 and 2007

1) S was born in an odd number year.

2) The difference between the present age of S and V is 5.

(as a difference of 5 years is between the person born in 1956 and 1961 and person born in 1973 and 1978 as S born in an odd-numbered year, therefore, S born either in 1961 or 1973 and V born in 1956 and 1978)

3) Only 3 people were born between V and T.

		Case – 1	Case – 2
Year	Age	Person	Person
1945	73		T
1956	62	V	
1961	57	S	
1973	45		S
1978	40		V
1989	29	T	
1996	22		
2007	11		

4) The number of people born between T and Q is the same as the number of people born between T and P.

(As we can see in the above table it is the only possibility that P and Q born just before and after T or only one person between born between P and T and T and Q)

(here case - 2 will get eliminated as in this case it is not possible that people born between T and P is the same as T and Q)

5) The present age of W is twice the present age of Q.

(This is only possible if Q's age is 11 years and W's age is 22 years)

Case - 1		
Year	Age	Person
1945	73	
1956	62	V
1961	57	S
1973	45	P
1978	40	
1989	29	T
1996	22	W
2007	11	Q

5) R was born in one of the years before P. (Now only U is left and the only birth year left is 1978. Therefore, U born in 1978)

Year	Age	Person
1945	73	R
1956	62	V
1961	57	S
1973	45	P
1978	40	U
1989	29	T
1996	22	W
2007	11	Q

Above combination will be the final combination.

Age of U is 40 years.

30. Ans. E.

Person: P, Q, R, S, T, U, V and W

Birth year: 1945, 1956, 1961, 1973, 1978, 1989, 1996 and 2007

1) S was born in an odd number year.

2) The difference between the present age of S and V is 5.

(as a difference of 5 years is between the person born in 1956 and 1961 and person born in 1973 and 1978 as S born in an odd-numbered year, therefore, S born either in 1961 or 1973 and V born in 1956 and 1978)

3) Only 3 people were born between V and T.

		Case - 1	Case - 2
Year	Age	Person	Person
1945	73		T
1956	62	V	
1961	57	S	
1973	45		S
1978	40		V
1989	29	T	
1996	22		
2007	11		

4) The number of people born between T and Q is the same as the number of people born between T and P.

(As we can see in the above table it is the only possibility that P and Q born just before and after T or only one person between born between P and T and T and Q)

(here case - 2 will get eliminated as in this case it is not possible that people born between T and P is the same as T and Q)

5) The present age of W is twice the present age of Q.

(This is only possible if Q's age is 11 years and W's age is 22 years)

Case - 1		
Year	Age	Person
1945	73	
1956	62	V
1961	57	S
1973	45	P
1978	40	
1989	29	T
1996	22	W
2007	11	Q

5) R was born in one of the years before P.

(Now only U is left and the only birth year left is 1978. Therefore, U born in 1978)

Year	Age	Person
1945	73	R
1956	62	V
1961	57	S
1973	45	P
1978	40	U
1989	29	T
1996	22	W
2007	11	Q

Above combination will be the final combination.

Hence, R was born in 1945.

31. Ans. E.

From I and II,

F is 2nd to the left of D. C is 2nd to the left of F. C is to the immediate left of B. E is 2nd to the left of B and B is facing away from the centre.

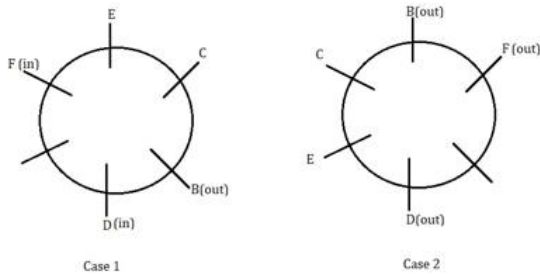

B is not a neighbor of F so case 2 gets rejected. B is 2nd to the right of A. C's neighbors are facing opposite directions to each other. F is 2nd to the right of C.

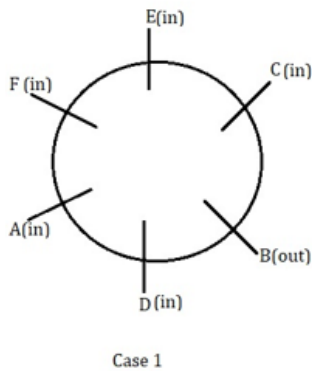

Clearly, five persons are facing the centre. So I and II together are necessary to answer the question. Hence, option E.

32. Ans. E.

From I and II,

A was born in a month which was having 30 days so A either born in April or June.

If A was born in June: Two persons were born between A and D. One person was born between D and E then D was born in March and E was born in May. One person was born between E and C then C was born in July. Now three persons were born between D and C.

If A was born in April: Two persons were born between A and D. One person was born between D and E then D was born in July and E was born in May. One person was born between E and C then C was born in March. Now three persons were born between D and C.

So statement I and II are together necessary to answer the question.

Hence, option E.

33. Ans. D.

From **Statement I:**

Either Neha or Abhay is sitting at one of the ends. Abhay is third to the left of Neha.

Deepak is fourth to the left of Poorvi. The possible scenarios can be

I. Deepak _ Abhay _ Poorvi Neha

II. Abhay Deepak _ Neha _ Poorvi

So, we can't find who are sitting at the extreme ends.

From **Statement II:**

Abhay _ Poorvi or Poorvi _ Abhay and neither of them is sitting at the ends.

The possible scenarios can be

I. Manik Abhay _ Poorvi Neha

II. Poorvi Neha _ Abhay Manik

So, we can't find who are at the extreme ends.

From Statements I and II

The only possible scenario is Deepak Manik Abhay Hitesh Poorvi Neha.

Thus, Deepak and Neha are sitting at the extreme ends.

34. Ans. A.

From statement 1, $E > B > C$, D (In weight) but E is not the heaviest that means A is the heaviest.

$A > E > B > C$, D

From statement 2, $A > E > B, C$. So, D could be either the heaviest or the lightest.

Statement 2, does not clarify

Hence, statement 1 alone is sufficient to answer the question.

35. Ans. E.

From I and II,

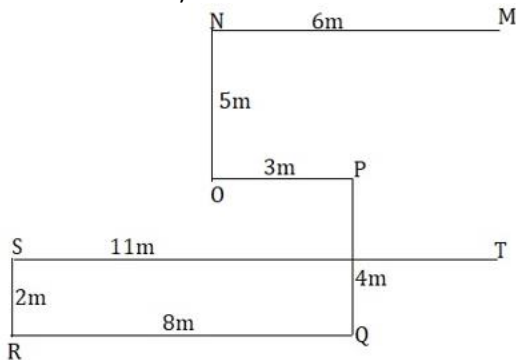

So point M is north of point T.

So I and II together are necessary to answer the question.

Hence, option E.

36. Ans. E.

Amount invested in scheme A be Rs. X and amount invested in scheme B be Rs. (7000-X)

Interest earned from scheme A = $X \times [10 + 10 + (10 \times 10)/100]\% = X \times (21/100)$

Return from Scheme B = $(7000 - X) \times (3 \times 15/100) = (7000 - X) \times 45/100$

ATQ

$X \times (21/100) = [(7000 - X) \times 45/100] \times (84/100)$

$\Rightarrow X = (7000 - X) \times 1.8$

$\Rightarrow 2.8X = 7000 \times 1.8$

$\Rightarrow X = 7000 \times (18/28) = 4500$

Hence, answer is option E.

37. Ans. A.

Let the number of red balls be X, then

Probability of getting 1st ball red = $X/(X+5)$

Probability of getting 2nd ball red (Without replacement) = $(X-1)/(X+4)$

Probability of getting both balls red = $[X/(X+5)] \times [(X-1)/(X+4)] = 3/7$

On solving, we get

$X = 10$

38. Ans. C.

A alone can do = 20days

Efficiency ratio of A & B = 4 : 5

Time required will be in ratio = 5:4

Hence B alone will do it in = 16 days

LCM of (16,20) = 80, Assume work size of 80 units

1 day work of A = 4 units

1 day work of B = 5 units

Work done by both in 4 days = $4 \times (5+4) = 36$ units

Work left = $80 - 36 = 44$ units

Now C takes 22 days to complete = 44 units.

Therefore, the efficiency of C = $44/22 = 2$

Hence time taken by C alone to complete the work = $80/2 = 40$ days

39. Ans. C.

Say haircut voucher = H pedicure voucher P

$H + P = 450$

$H = 290, P = 160$

Male getting pedicure = $160 \times (13/20) = 104$

Female Getting Pedicure = $160 \times (7/20) = 56$

Male Haircut = $104 + 15 = 119$

Female haircut = $290 - 119 = 171$

	Male	Female	Total
Haircut	119	171	290
Pedicure	104	56	160
Total	223	227	450

Required % = $(56/290) \times 100 = 19\%$

approximately

40. Ans. D.

Say haircut voucher = H pedicure voucher P

$H + P = 450$

$H = 290, P = 160$

Male getting pedicure = $160 \times (13/20) = 104$

Female Getting Pedicure = $160 \times (7/20) = 56$

Male Haircut = $104 + 15 = 119$

Female haircut = $290 - 119 = 171$

	Male	Female	Total
Haircut	119	171	290
Pedicure	104	56	160
Total	223	227	450

Total for manicure = $30 + 50\%$ of 290

= $30 + 145 = 175$

41. Ans. D.

Say haircut voucher =H pedicure voucher P =H-130

H+P= 450,

H=290, P=160

Male getting pedicure= $160 \times (13/20) = 104$

Female Getting Pedicure= $160 \times (7/20) = 56$

Male Haircut= $104 + 15 = 119$

Female haircut= $290 - 119 = 171$

Males redeemed pedicure voucher= 104

	Male	Female	Total
Haircut	119	171	290
Pedicure	104	56	160
Total	223	227	450

42. Ans. C.

Say haircut voucher =H pedicure voucher P =H-130

H+P= 450,

H=290, P=160

Male getting pedicure= $160 \times (13/20) = 104$

Female Getting Pedicure= $160 \times (7/20) = 56$

Male Haircut= $104 + 15 = 119$

Female haircut= $290 - 119 = 171$

Males redeemed pedicure voucher= 104

	Male	Female	Total
Haircut	119	171	290
Pedicure	104	56	160
Total	223	227	450

43. Ans. D.

Say haircut voucher =H pedicure voucher P =H-130

H+P= 450,

H=290, P=160

Male getting pedicure= $160 \times (13/20) = 104$

Female Getting Pedicure= $160 \times (7/20) = 56$

Male Haircut= $104 + 15 = 119$

Female haircut= $290 - 119 = 171$

Males redeemed pedicure voucher= 104

	Male	Female	Total
Haircut	119	171	290
Pedicure	104	56	160
Total	223	227	450

Required Difference= $104 - 56 = 48$

44. Ans. A.

Required average= $\{98.75\% \text{ of } (2.8 + 3.6)\} / 2 = 3.16 \text{ lakh.}$

45. Ans. B.

Shirts failed test in 2014= $2.5\% \text{ of } 3.2 \text{ lakh} = 8000$

Shirts failed test in 2017= $1.25\% \text{ of } 3.6 \text{ lakh} = 4500$

Decrease in percentage= $(8000 - 4500) \times (100/8000) = 43.75\%$

46. Ans. D.

In the year 2015:

No. of coloured shirts : No. of white shirts = $3 : (3 - 1) = 3 : 2$

Hence, answer = $(3/5) \times 4 = 2.4 \text{ lakh}$

47. Ans. C.

Number of shirts, which passed the quality test in 2015 = $97.75\% \text{ of } 4.0 \text{ lakh}$

Hence, answer= $10\% \text{ of } (97.75\% \text{ of } 4.0 \text{ lakh}) = 39100.$

48. Ans. B.

Total no. of shirts passed the quality test = $3,20,000 \times (1 - 2.5/100) = 3,20,000 \times 97.5/100 = 3,12,000$

Hence, the total revenue = $3,12,000 \times 500 = \text{Rs.}15.6 \text{ Crore.}$

49. Ans. D.

Required number of large size woxx boxes = $36 + 42 + 32 + 46 + 70 = 226$

50. Ans. E.

Total number of sold woxx boxes on day 1 = $48 + 36 = 84$

Total number of sold woxx boxes on day 4 = $53 + 46 = 99$

Hence, the required percent = $(84/99) \times 100 = 84.84 \approx 84.9\%.$

51. Ans. D.

Total number of woxx box of medium size, sold on Day 1, Day 4 and Day = $48 + 53 + 40 = 141$

Hence, the required average = $141/3 = 47$

52. Ans. C.

Hence required ratio= $(60 + 40) : (48 + 32) = 100 : 80 = 5 : 4.$

53. Ans. A.

Required percentage = $[(40 - 32)/32] \times 100 = 25\%$

54. Ans. B.

Given, $r = 5$ cm and volume of cylinder =

$$\pi r^2 h = 500\pi$$

$$\Rightarrow h = 20 \text{ cm}$$

So, the diagonal of square = 20 cm

$$\Rightarrow \text{Side of the square} = \text{Diagonal} / \sqrt{2} = 20 /$$

$$\sqrt{2} = 10\sqrt{2} \text{ cm}$$

$$\therefore \text{Perimeter of square} = 4 \times \text{side} = 4 \times 10$$

$$\sqrt{2} = 40\sqrt{2} \text{ cm}$$

55. Ans. B.

$$A \quad 2x^2 + 5x + 3 = 0$$

$$\text{So } 2x^2 + 2x + 3x + 3 = 0$$

$$\text{So } 2x(x+1) + 3(x+1) = 0$$

$$\text{So } (2x+3)(x+1) = 0$$

$$\text{So } x = -3/2 \text{ or } x = -1$$

$$B. \quad 2y^2 - 7y + 6 = 0$$

$$2y^2 - 4y - 3y + 6 = 0$$

$$\text{So } y = +2 \text{ or } y = +3/2$$

Thus $x < y$

56. Ans. D.

$$A. \quad 3x^2 - 7x + 4 = 0$$

$$3x^2 - 4x - 3x + 4 = 0$$

$$X = 4/3 \text{ or } 1$$

$$B. \quad 2y^2 - 3y + 1 = 0$$

$$2y^2 - 2y - y + 1 = 0$$

$$Y = 1 \text{ or } 1/2$$

Thus D is correct

57. Ans. A.

$$A. \quad x^2 + 12x + 35 = 0$$

$$x^2 + 7x + 5x + 35 = 0$$

$$x = -7 \text{ or } -5$$

$$B. \quad y^2 + 17y + 72 = 0$$

$$y^2 + 8y + 9y + 72 = 0$$

$$Y = -8 \text{ or } -9$$

So $x > y$

58. Ans. D.

$$A. \quad x^2 - 10x + 25 = 0$$

$$x^2 - 5x - 5x + 25 = 0$$

$$x = +5$$

$$B. \quad y^2 = 25$$

$$Y = +5, -5$$

So $x \geq y$

59. Ans. B.

$$A. \quad x^2 - 36x + 324 = 0$$

$$x^2 - 18x - 18x + 324 = 0$$

$$x = 18$$

$$B. \quad y^2 - 42y + 441 = 0$$

$$y^2 - 21y - 21y + 441 = 0$$

$$y = 21$$

$$x < y$$

60. Ans. B.

In 30 minutes the train with 50 Km speed reach at a distance of 25 Km

And their relative speed is 25 Km/h

$$\text{So, Time take} \rightarrow 25/25 = 1 \text{ Hr}$$

Distance from Delhi the two trains will be together $\rightarrow 75 * 1 = 75 \text{ KM}$

61. Ans. D.

$$\text{Cost Price} = \text{Rs. } (50000 + 2000 + 500) = \text{Rs. } 52,500$$

$$\text{Profit} = 20\%$$

$$\text{Hence, selling price} = 120\% \text{ of } 52500 = \text{Rs.}$$

$$\text{Rs. } 63,000$$

62. Ans. A.

Let the number of persons in the group

Initially be x , then

$$x \times 16.75 + 20 \times 13.25 = (x + 20) \times 15$$

$$\Rightarrow 1.75x = 20 \times (15 - 13.25)$$

$$\Rightarrow 1.75x = 20 \times 1.75$$

$$\Rightarrow x = 20$$

63. Ans. E.

$$A_{2001}:A_{2002} = 4:5$$

$$A_{2001}:B_{2001} = 2:3$$

We have to make A_{2001} same in both cases.

$$A_{2001}:B_{2001} = 4:6$$

$$\text{Let A's income in 2001} = 4x$$

$$\text{Let B's income in 2001} = 6x$$

$$\text{A and B income in 2001} = 25000 [\text{Given}]$$

$$10x = 25000$$

$$x = 2500$$

$$\text{A's income in 2001} = 4x = 4 * 2500 =$$

$$\text{Rs } 10000$$

$$\text{B's income in 2001} = 6x = 6 * 2500 =$$

$$\text{Rs } 15000$$

$$\text{A's income in 2002} = 5x = 5 * 2500 =$$

$$\text{Rs } 12500$$

$$\text{Savings of A in 2002} = \text{Rs } 4000$$

$$\text{Expenditure} = \text{Income} - \text{Savings} = 12500 -$$

$$4000 = \text{Rs } 8500$$

64. Ans. A.

Let the current ages be y and $3y$

Their ages after 5 years $\rightarrow y+5$ & $3y+5$

$$\rightarrow (y+5)/(3y+5) = 3/4 \rightarrow y = 1$$

So, their current ages are 1 & 3 years and

after 10 years the average age be 12 years.

65. Ans. A.

Ratio of mixture of spirit and water in Container 1 = 2: 3

Amount of mixture taken = 10 litres

Amount of spirit = $\frac{2}{5} \times 10 = 4$ litres

Amount of water = $\frac{3}{5} \times 10 = 6$ litres

Ratio of mixture of spirit and water in Container 2 = 3: 2

Amount of mixture taken = x litres

Amount of spirit = $\frac{3}{5} \times x = \frac{3x}{5}$ litres

Amount of water = $\frac{2}{5} \times x = \frac{2x}{5}$ litres

Ratio of mixture of spirit and water in resultant mixture = 4: 5

Therefore, $\frac{4 + \frac{3x}{5}}{\frac{6 + 2x}{5}} = \frac{4}{5}$

$\frac{20 + 3x}{30 + 2x} = \frac{4}{5}$

$\frac{20 + 3x}{30 + 2x} = \frac{4}{5}$

$100 + 15x = 120 + 8x$

$7x = 20; x = 2.86$ litres

So option (1) is the correct answer.

66. Ans. B.

0.5, 2, 1, 4, 32, 512

taking from opposite side

$512 \div 2^4 = 32$

$32 \div 2^3 = 4$

$4 \div 2^2 = 1$

$1 \div 2^1 = 0.5 \neq 2$

$0.5 \div 2^0 = 0.5$

hence 2 is wrong term.

67. Ans. B.

$5.1 = 4 + 1.1$

$7.3 = 5.1 + 2.2$

$10.6 = 7.3 + 3.3$

$15 = 10.6 + 4.4$

$20.5 = 15 + 5.5$ (Hence, 20 is the wrong term)

$27.1 = 20.5 + 6.6$

68. Ans. D.

$3 = (2 \times 2) - 1$

$8 = (3 \times 3) - 1$

$31 = (8 \times 4) - 1$

$154 = (31 \times 5) - 1$

$923 = (154 \times 6) - 1$ (Hence, 924 is the wrong term)

$6460 = (923 \times 7) - 1$

69. Ans. D.

$134 - 69 = 65$ further $65 - 33 = 32$

$69 - 36 = 33$ $33 - 17 = 16$

$36 - 19 = 17$ $17 - 9 = 8$

$9 - 10 = 9$ $9 - 5 = 4$

$10 - 5 = 5$

70. Ans. B.

$251 - 1^3 = 250$ ----(Hence, 252 is the wrong term)

$250 + 2^2 = 254$

$254 - 3^3 = 227$

$227 + 4^2 = 243$

$243 - 5^3 = 118$

$118 + 6^2 = 154$

71. Ans. E.

Refer to the following sentences from the passage:

I. "These **mismatched graduates** face poorer prospects and lower earnings than their peers who embark on careers that are a better fit for the knowledge and skills they have acquired through three or four years of study. It suggests that traditional careers advice isn't working." The mismatched graduates are those who do not end up getting the job that they are skilled in. Thus, alternative I is correct.

II. "To help graduates find the right jobs for them, lots of universities are experimenting with new ways to make their careers advice more accessible and meaningful." This means that many universities are addressing the problem of mismatched jobs.

III. "The problem isn't necessarily that too many students are taking the wrong course. There is little evidence that graduates are studying the "wrong" subjects, according to the UUK research, since most are on courses that offer subject knowledge and employability skills that are very much in demand...Instead, students need better careers advice that will help them define their skills and attributes." The passage discusses how graduates end up being mismatched to the jobs they find after university. He/ She finds that the lack of a good career is the root cause of this problem.

All the statements are correct and option E is the correct answer.

72. Ans. B.

The third and the fourth paragraphs of the passage suggest that students are not opting for the wrong courses, but they have not been

counselled appropriately to get the job that matches their knowledge and skills. Thus, option B is the correct answer.

73. Ans. E.

The author of the passage supports the university graduates need to be provided professional advice with respect to the career they must opt for. This would save them from making unsuitable career choices. According to the passage, "Students also need help finding out which skills they'll need to break into certain industries - **particularly in sectors that aren't good at diversifying their recruitment, or when they have no family or social network of contacts to call on for help and advice.**" Thus, option E is the most suitable answer.

74. Ans. A.

Option A is the correct answer. The author of the passage points out that many employers prefer recruiting young people who have spent a couple of years in the workplace rather than raw recruitments from university. This implies that the problem lies in the lack of experience as opposed to the lack of skills, something which the politicians complain of. Thus the mentioned sentence implies that the politicians have not been able to properly analyse the root cause of the problem that lands up a student in an undesirable job. Option A is the correct answer.

75. Ans. B.

"Evidence" means proof. Thus, option B is the correct answer.

Rustic- made in a plain and simple fashion.
Misnomer- a wrong or inaccurate use of a name or term.

76. Ans. C.

"Embark" means to begin (a course of action). Thus, option A is the synonym of "embark". "Reject" is the correct antonym of the given word.

Apprehend- understand or perceive.

77. Ans. E.

All the three statements use the word "hamper" in the correct form. In the first and the second sentence, the word has been used as a verb in the present and the past tense respectively. "Hamper" means to cause

hindrance. The third sentence uses the word as a noun which means a basket or a container. The word fits appropriately in the given question. Since the word has been used correctly in all the sentences, option E is the correct answer.

78. Ans. D.

Tact— skill and sensitivity in dealing with others or with difficult issues
Tactfully— with skill and sensitivity in dealing with others or with difficult issues
Tactful— having or showing skill and sensitivity in dealing with others or with difficult issues

"Tactful" fits in statement I as an adjective is required to define the judge.

"Tact" fits in statement III as it has been correctly used as a noun in the sentence.

"Tactfully" is an adverb which can modify a verb, an adjective or another adverb. The word does not fit in the second sentence as one cannot come up with a "tactfully", but with a tact.

Since only statements I and III are correct, option D is the correct answer.

79. Ans. A.

"Adage" is a noun which means a proverb or short statement expressing a general truth. The word cannot be used in the verb or a gerund form, thus, statements II and III are incorrect. The word has been used correctly only in statement I. Thus, option A is the correct answer.

80. Ans. B.

"Malaise" (noun) means uneasiness or restlessness. The word has been correctly used only in statement II. The other two sentences use the forms of the word which do not exist in the Standard English language. Thus, option B is the correct answer.

81. Ans. E.

When we use 'rather', we mention the opposite of that action in the next phrase. Since circular and linear are opposite, A & E go together. C and F also connect appropriately.

82. Ans. C.

All the given sentences are about oceans. Nothing is related to farmers. B ends with

'around' which indicates there must be a location mentioned in the next part of the statement. None of the segments in column II does that. Both D & F can follow A. But none of the options mentions A- D as a pair. So, D will follow C and F will follow A. Hence, the correct answer is C.

83. Ans. A.

Statement A ends with 'completely', an adverb. This means the part following it must start with a main verb. None of the clauses in column II do so. Statement C ends with 'of' which indicates that the next part must describe an attribute of the subject (Unsustainable fishing practices). Grammatically, both E & F can do that. But, none of the options has C- E as a pair. So, F would be more appropriate after C. B & E can be joined correctly. Hence, the correct answer is A.

84. Ans. D.

There is only one 'social media market giant' in column I, i.e. is Facebook. So, B goes with F. No other combinations can be formed correctly. Hence, the correct answer is option D.

85. Ans. B.

Care of calves and humans cannot be picked up for listening. So, B goes with F. Preferring one appendage over another, is a habit also seen, in humans i.e. being right or left handed. So, A & E go together. Older females do care of the young ones. so, C goes with D. Hence, the correct answer is option B.

86. Ans. A.

"Displacing" is a continuous verb which does not make much sense here. Thus, the noun "displacement" should be written instead of "displacing". Also, the sentence talks about climatic changes, thus, the word "weather" should be used instead of "whether". Since only (i) is correct, thus, option A is the correct answer.

Note that "weather" (alternative i) and whether (alternative ii) are two different words carrying different meanings.

87. Ans. B.

The subject here is "incidents" which is plural, thus, the verb should be plural too. Hence,

"have" should be used instead of "has". Moreover, 'spotlight in' will get replaced by the 'spotlight on' as there should be a proper use of preposition. 'To put the spotlight on' something means to highlight it. Thus, option B is the correct answer.

88. Ans. C.

"Cost" is a singular subject, thus the auxiliary verb "is" should be used. Thus, option C is the correct answer.

"More" represents comparative degree, hence, "the" cannot be used before it, hence, (ii) is incorrect. Thus, option C is the correct answer.

89. Ans. A.

"Six" is a plural number, thus, 'years' should be in plural as the preposition "of" is used after it. In contrast, in compound nouns, the singular forms are used. E.G. I saw a **ten year** old boy steal from the shop. Additionally, in the highlighted part, the phrase "in qualitatively" is incorrect as "qualitatively" is an adverb. To make the sentence correct, the noun "quality" should be used. Since (i) makes both the corrections, option A is the correct answer.

90. Ans. A.

The subject here is "meritocracy", hence, the singular verb "has" should be used instead of "have". "Examining" as given in alternative (iii) is not a word in Standard English, hence incorrect. Thus, option A is the answer.

91. Ans. B.

The error is in part B of the sentence, which means the word "underline" has been used wrongly here. Note that the word mentioned after "underline" is "problem", which is a noun. So, we need an adjective to modify this noun. Thus, "underlined" should replace the highlighted word mentioned in B. An underlined problem means an emphasised problem.

92. Ans. B.

The error is in part B of the sentence, which means the word "vertebrate" has been used wrongly here. Note that the sentence mentions that the heat causes some action in the molecules, which means we need a verb instead of the noun "vertebrate" (an animal of

a large group distinguished by the possession of a backbone or spinal column). Thus, the word "vibrate" must be used which means move continuously and rapidly to and fro.

93. Ans. B.

Fleet is the collective noun used for ships. Here, 'sheeps' has been used in the first part, which needs to be replaced with 'ships'.

94. Ans. B.

Dew should be replaced by due. Dew means tiny drops of water that form on cool surfaces at night, when atmospheric vapour condenses. Due to means owing to something or because of something.

95. Ans. A.

Here "creating" should be used in place of "created" in order to make sentence context appropriate.

96. Ans. B.

The usage of "however" in one of the segments suggests that a contradiction to a mentioned clause will be presented in the other clause. The sentence cannot start with the conjunction, "however". This eliminates options D and E. Part C cannot begin the sentence either as it would fail to make a logical sentence. E cannot immediately follow C, thus, the correct sequence is DBCAE and option B is the correct answer.

97. Ans. B.

The sentence should start with the main subject, which in this case is "Harry and

Meghan's little one". The little one's objective is given by segment B and hence that should follow A. Of all the options, it is option B which has AB as the opening pair. Option B is the correct answer and the correct sequence is ABCDE.

98. Ans. C.

The segments cannot be arranged in any of the given sequences as there are grammatical errors in it.

99. Ans. D.

The theme of the sentence is centred around the given words, "resilient" "resilience" and "resiliency". Thus, A and D can be used to start the sentence. Of the two, A must be followed by D. Now E tells us about the use of the words, which is applied to victims. Thus, the sequence so far is ADE. The option with the same sequence is D and the correct sequence is ADEBC.

100. Ans. E.

The sentence is about Lauren Mayberry. Thus, segment A should start the sentence. Frontwoman means the leading singer in a band, thus, logically she got on to the stage must follow A. She took the stage in something that was pastel coloured. This inadvertently means that she was dressed up in a dress which was pastel in colour. What must follow E is D. The option with the sequence AED is option E and AEDBC is the correct order.
